





GT - SBSP 1000

-  Sollevatore mobile per batterie a doppia forbice
-  Mobile battery lift with double scissors
-  Mobiler Lifter für Batterien mit Doppelschere
-  Elévateur mobile pour batteries à double ciseaux
-  Elevador móvil para baterías con doble tijera



1.000 Kg





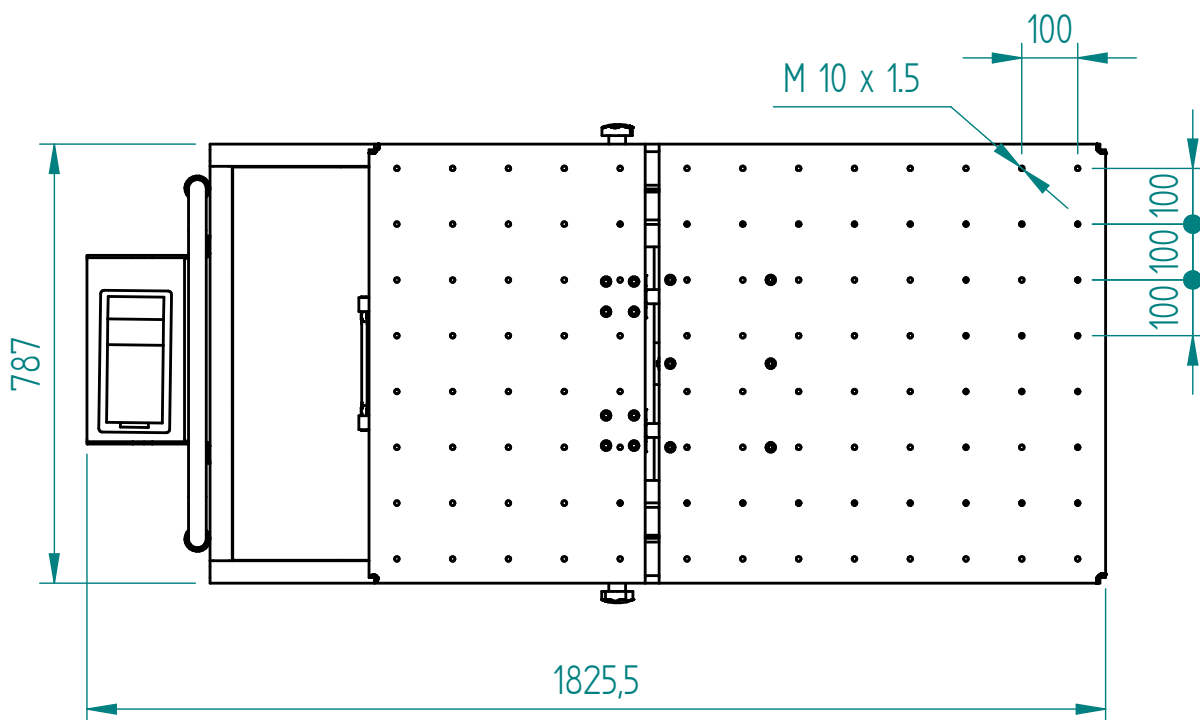
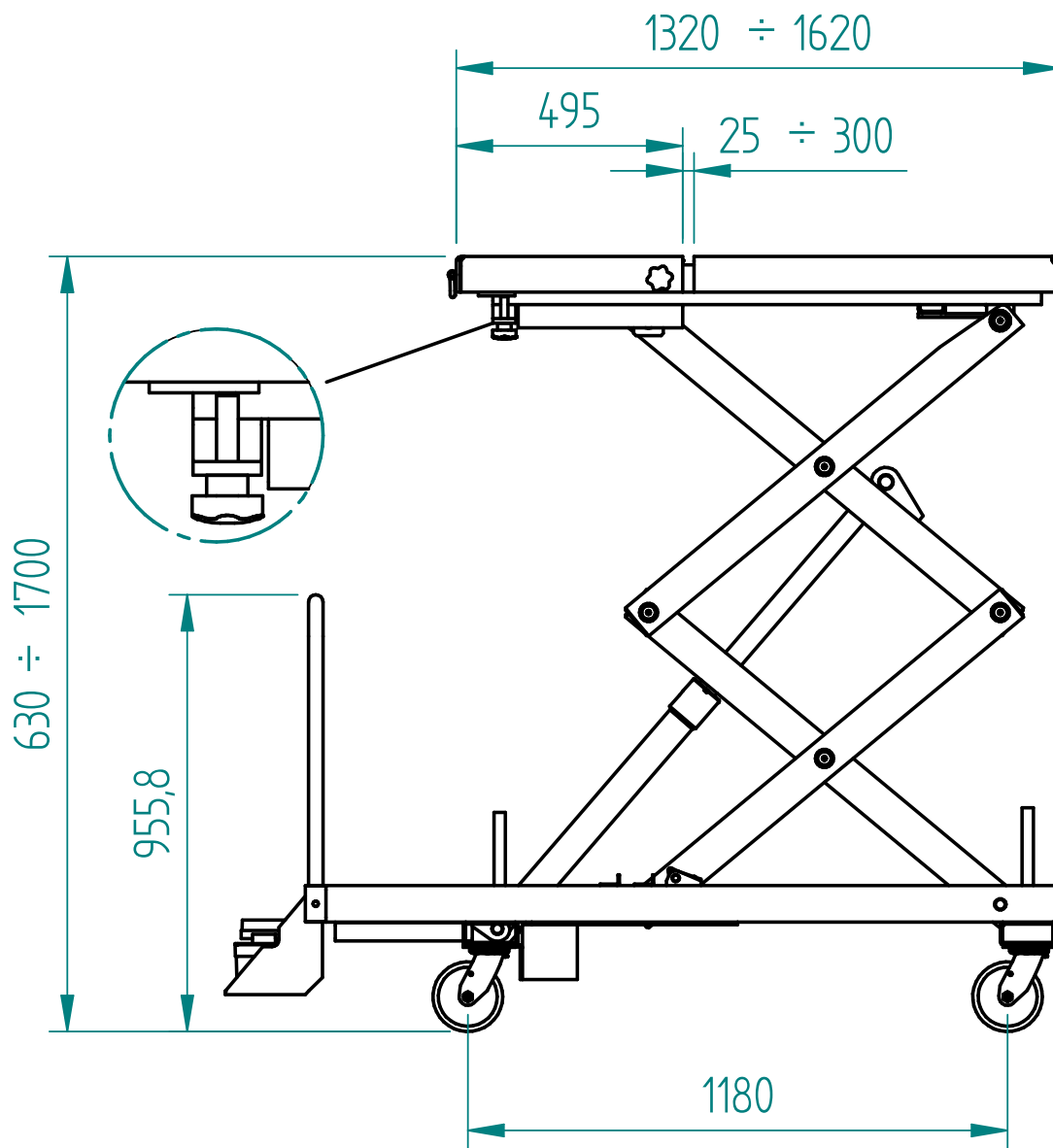

DATI TECNICI	TECHNICAL DATA	TECHISCHE DATEN	DONNÉES TECHNIQUES		
Portata max.	Max. capacity	Max. Tragfähigkeit	Portée max.	kg	1000
Tempo di salita / discesa	Lifting / lowering time	Hubfahrt-/ Senkfahrdauer	Temps de montée / descente	s	35/20
Alimentazione	Power supply	Stromversorgung	Alimentation		in 6/8 bar (120 on working)
Peso totale	Total weight	Gesamtgewicht	Poids total	Kg	385
Altezza sollevamento	Lift height	Höhe Aufzug	Altura ascensor	mm	630-1700
Tensione circuito comandi	Circuit voltage command	Leerlaufspannung Befehl	Circuit de commande de tension	V	--







MECHANICAL SAFETY LOCK WITH MANUAL RELEASE SICURA MECCANICA CON SGANCIO MANUALE

- 
 • Adatto e pratico per sollevare motori auto / cambi / batterie.
- 
 • Geeignet und praktisch zum Heben von Automotoren / Getrieben / Batterien.
- 
 • Adecuado y práctico para levantar motores de automóviles / cajas de cambios / baterías.
- 
 • Suitable and practical for lifting car engines / gearboxes / batteries for electric or hybrid cars.
- 
 • Convient et pratique pour soulever les moteurs / boîtes de vitesses / batteries de voiture.
- Il sollevatore ha la copertura traslante con possibilità di aprirsi e permettere all'operatore di avere lo spazio per sganciare la batteria della vettura comodamente.
- Der Aufzug hat eine Übersetzungsabdeckung mit der Möglichkeit, den Mechaniker Platz zu geben, um die Autobatterie bequem freizugeben.
- El puente tiene una plataforma que se abre y permite que el operador tenga espacio para liberar la batería del automóvil cómodamente.
- the movement of the lift is pneumatic.
- le mouvement du pont est pneumatique.
- Le pont a une plate-forme qui s'ouvre et permet à l'opérateur d'avoir suffisamment d'espace pour libérer la batterie de la voiture confortablement.
- le mouvement du pont est pneumatique.

BATTERY LIFTS CAN BE USED FOR SEVERAL USE INSTALLING GEAR BOX - ENGINES - BATTERY



GT-1.5EF SB 1500Kg/3300lbs

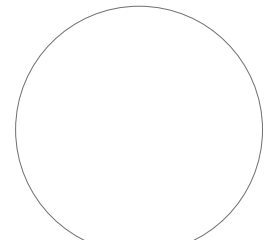

Pneumatic foot pump

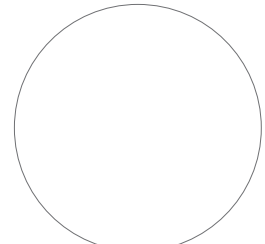

Mechanical safety latch with manual release

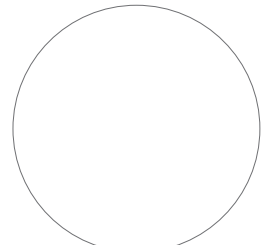

Manual lock release handle

Two separated T- handle adjustment screws for asymmetric tilting of table surface.

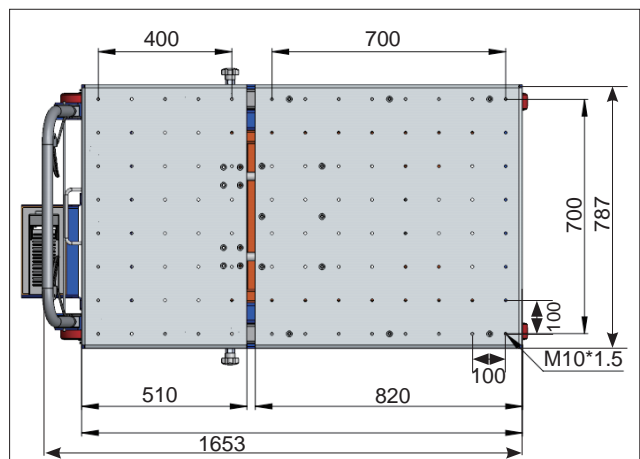

Features:

- 1 Multi functional workbench surface
- 2 Min. height: 700mm, max. lifting height:2000mm.
- 3 With universal wheel and directional wheel for convenient movements.
- 4 M10×1.5 metric threaded holes integrated in top for mounting of optional future adapters.
- 5 Two adjustment screws for securing top when used as work bench surface.
- 6 Detent pin for locking table top in three open position.